



The Brighter Choice



Line B

Line C



TEXAS PRO

High performance batten



TEXAS PRO

Introducing our new high-performance LED batten, thoughtfully engineered for effortless installation. Featuring a convenient push-button hinged opening and a movable terminal block, this design ensures a quick and hassle-free installation every time.

TEXAS PRO offers exceptional efficiency and dependable reliability. It includes switchable power settings, selectable CCT, and a comprehensive range of control and emergency options, making it the perfect choice for projects where performance, ease of installation and long-term reliability matter.

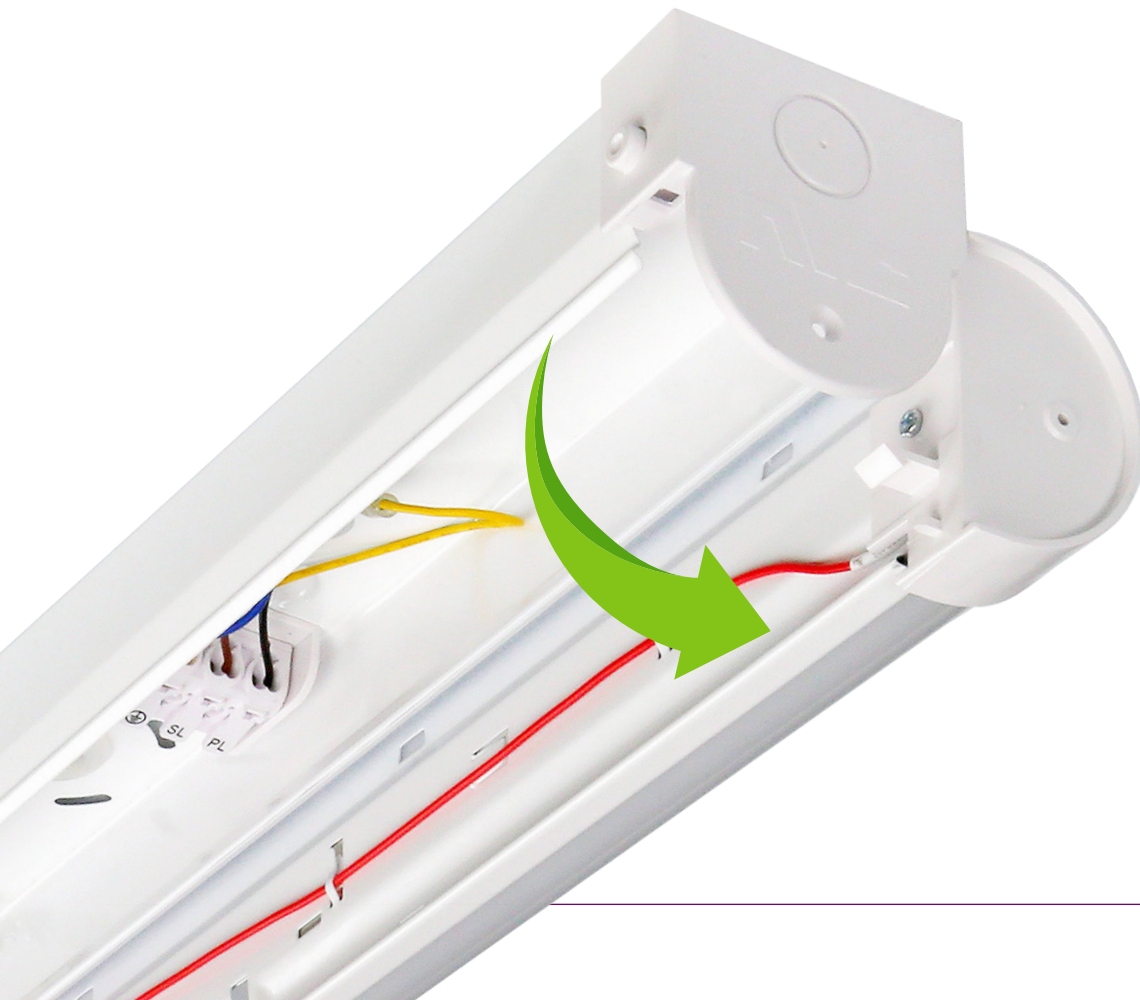

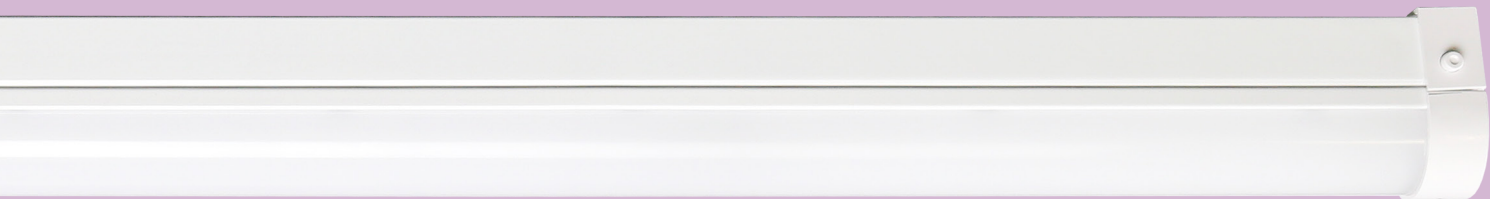

KEY FEATURES

TEXAS PRO features a hinged one-piece light engine with an opal diffuser, mounted on a robust steel body.

EFFICIENT

Outstanding efficiency of up to 168 luminaries lumens per circuit watt



SIZES

TEXAS PRO is available in 4ft, 5ft and 6ft lengths.



POWER SELECTABLE

Choose between high and low output non-dimming variants with 4-way power selection allowing you to tailor the light output to the project requirements.



CCT SELECTABLE

3000K, 4000K and 6000K

All variants can be switched between 3000K, 4000K, or 6000K as standard.

CONTROLS & DIMMING

TEXAS PRO can be supplied with wired or wireless dimming drivers. An integral microwave motion sensor is also available.



EMERGENCY OPTIONS

TEXAS PRO is available with manual test, self test, or addressable emergency options.

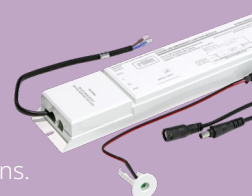

7 YEAR WARRANTY

TEXAS PRO is backed by a 7-year PROe warranty, covering unlimited operating hours from the date of installation. Emergency batteries are included under this warranty.



RELIABLE

Rated for 100,000 hours (L80) lifetime with low depreciation. At the end of its rated life TEXAS PRO will still deliver at least 80% of its initial output.



Note – not all options are available in all combinations. Please check our website or call our technical team on +44 (0)121 457 6340 for details.

BESA Fixing Points
Simplifies rear cable entry.

Efficient
Up to 168 l.lm/c.W

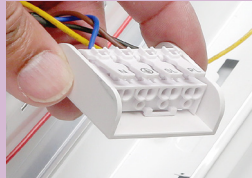

Movable terminal block
Snap-fit locations at either end and at the centre to suit the cable entry.

TEXAS PRO

Push-button hinge opening and a movable terminal block makes TEXAS PRO simple to install.

Quick to install in easy steps

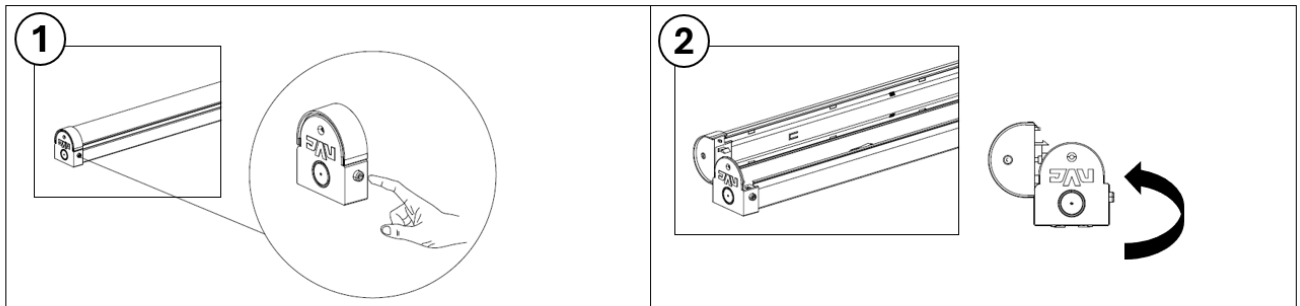

1 Push endcap buttons to open fitting.

2 Hinge body open for installation.

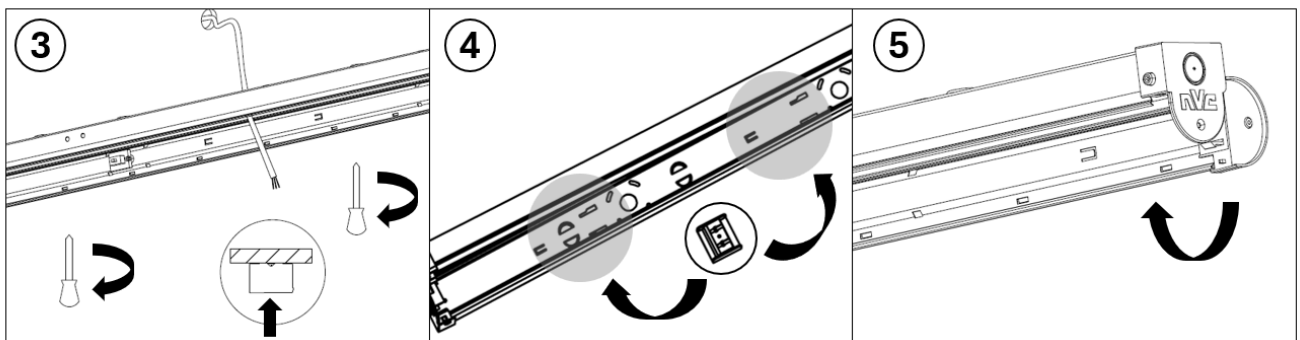

3 Insert cable through rear or ends.
Fix to ceiling.

4 Move terminal block to desired location
and connect cable.

5 Close hinged cover.

Power selection
4 way power switching
for tailored light output.



CCT selector switch
Select between 3000K,
4000K or 6000K.



Tridonic driver
Tridonic driver fitted as standard
on all non-dimming variants.
100,000 hours rated.

Knock-out end entry
Simplifies through wiring.

Push-button hinge opening
Push buttons each end
make opening easy.
Light engine hinges down.

One piece light engine
Polycarbonate diffuser with
LEDs on a steel tray.

Emergency & sensor ready
Plug/socket connectors make fitting an
emergency conversion pack and/or a
microwave sensor easy.



TEXAS PRO can be ordered with a microwave sensor and / or an emergency pack ready fitted.

Alternatively, fittings can be converted onsite using the emergency and microwave sensor conversion packs. It's easy – all the connections are plug-and-play. No tools required.



EMERGENCY

TEXAS PRO is available with our full selection of factory built 3 hour emergency options. Choose from manual test, self test, or addressable test options.

Manual and self-test conversion packs are also available for onsite conversion.

All TEXAS PRO emergency luminaires and conversion packs have a 7 year warranty, including the LiFePO₄ Lithium battery.



Emergency testing - what are the options?

MANUAL TEST

A manual key switch is required. Because testing, checking, and record-keeping are all manual operations, this option has the highest testing costs. It is recommended for smaller projects.

SELF-TEST

Automated testing, with a fixed schedule, but record keeping is still manual. For small to medium-sized projects, self-test offers a rapid payback

DALI ADDRESSABLE TEST

Fully automated testing, reporting, and recording deliver the lowest testing cost. Choose from wired DALI or wireless Casambi or HubSense options for reduced installation costs. This is a great solution for large projects.

	MANUAL	SELF-TEST	DALI ADDRESSABLE	WIRELESS ADDRESSABLE CASAMBI or HubSense
Testing	Manual	Automated	Programmable	Programmable
Scheduling	No	Fixed	Programmable	Programmable
Recording	Manual	Manual	Automated	Automated
Reporting	Manual	Manual	Automated	Automated
Additional Wiring	Wiring to key switch	None	Bus wires for addressing	Wireless Addressing

DIMMING & SENSORS

TEXAS PRO is available with a range of factory fitted, energy saving control options.

Corridor function (CF)

The corridor function dims to 10% and is commonly used for corridors linked to a sensor in an adjoining room. As long as movement is detected in the room, the corridor lighting stays at 10%. When someone enters the corridor, the lighting automatically increases to full brightness.

Microwave sensor (MW)

An internal microwave motion sensor is available either factory fitted or as a plug and play kit for onsite conversion.



Digital Dimming (DD)

The digital dimming option supports DALI dimming and switch dim - manual dimming using a retractive switch.



SMART WIRELESS CONTROLS

CASAMBI or HubSense

TEXAS PRO can be supplied with either HubSense or Casambi smart wireless control built-in.

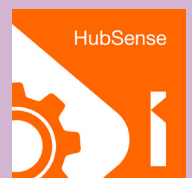

Casambi and HubSense use Bluetooth wireless technology to provide comprehensive lighting control, including scene setting, energy saving and addressable emergency testing.

Wireless control systems are simple to install because they do not require additional communication wiring, unlike conventional DALI installations. Commissioning is streamlined through an app on your smartphone or tablet. If required, a gateway can be added to enable remote access—useful for monitoring emergency fittings across multiple sites and performing remote diagnostics.

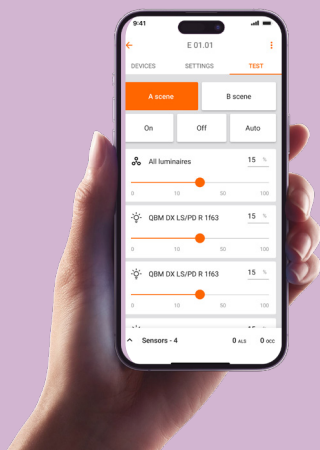

Contact our technical team for details – technical@nvcuk.com

Standard

ORDER CODE	DIMENSIONS LENGTH (mm)	POWER (W)	LUMENS (lm)*	EFFICACY (l.lm/c.W)	DIMMING	EMERGENCY	CRI	CCT (K)
NTE4/11-20/830-40-60	1174	11 / 14 / 17 / 20	1756 / 2180 / 2633 / 3047	156 / 159 / 159 / 159			>80	3000 / 4000 / 6000
NTE4/11-20/M3L/830-40-60	1174	11 / 14 / 17 / 20	1756 / 2180 / 2633 / 3047	156 / 159 / 159 / 159		M3L	>80	3000 / 4000 / 6000
NTE4/18-33/830-40-60	1174	18 / 23 / 28 / 33	2887 / 3625 / 4288 / 4991	160 / 161 / 160 / 158			>80	3000 / 4000 / 6000
NTE4/18-33/M3L/830-40-60	1174	18 / 23 / 28 / 33	2887 / 3625 / 4288 / 4991	160 / 161 / 160 / 158		M3L	>80	3000 / 4000 / 6000
NTE5/18-32/830-40-60	1464	18 / 23 / 27 / 32	2924 / 3747 / 4439 / 5187	161 / 167 / 166 / 165			>80	3000 / 4000 / 6000
NTE5/18-32/M3L/830-40-60	1464	18 / 23 / 27 / 32	2924 / 3747 / 4439 / 5187	161 / 167 / 166 / 165		M3L	>80	3000 / 4000 / 6000
NTE5/29-52/830-40-60	1464	29 / 37 / 45 / 52	4794 / 5923 / 7058 / 8132	168 / 167 / 164 / 162			>80	3000 / 4000 / 6000
NTE5/29-52/M3L/830-40-60	1464	29 / 37 / 45 / 52	4794 / 5923 / 7058 / 8132	168 / 167 / 164 / 162		M3L	>80	3000 / 4000 / 6000
NTE6/21-38/830-40-60	1734	21 / 27 / 32 / 38	3377 / 4270 / 5067 / 5925	164 / 165 / 164 / 162			>80	3000 / 4000 / 6000
NTE6/21-38/M3L/830-40-60	1734	21 / 27 / 32 / 38	3377 / 4270 / 5067 / 5925	164 / 165 / 164 / 162		M3L	>80	3000 / 4000 / 6000
NTE6/32-58/830-40-60	1734	32 / 40 / 50 / 58	5165 / 6388 / 7705 / 8827	164 / 163 / 160 / 157			>80	3000 / 4000 / 6000
NTE6/32-58/M3L/830-40-60	1734	32 / 40 / 50 / 58	5165 / 6388 / 7705 / 8827	164 / 163 / 160 / 157		M3L	>80	3000 / 4000 / 6000

* RESULTS @ 4000K

Digital Dimming (DD)

ORDER CODE	DIMENSIONS LENGTH (mm)	POWER (W)	LUMENS (lm)*	EFFICACY (l.lm/c.W)	DIMMING	EMERGENCY	CRI	CCT (K)
NTE4/11-20/DD/830-40-60	1174	11 / 14 / 17 / 20	1756 / 2180 / 2633 / 3047	156 / 159 / 159 / 159	Digital Dimming		>80	3000 / 4000 / 6000
NTE4/11-20/DD/M3L/830-40-60	1174	11 / 14 / 17 / 20	1756 / 2180 / 2633 / 3047	156 / 159 / 159 / 159	Digital Dimming	M3L	>80	3000 / 4000 / 6000
NTE4/18-33/DD/830-40-60	1174	18 / 23 / 28 / 33	2887 / 3625 / 4288 / 4991	160 / 161 / 160 / 158	Digital Dimming		>80	3000 / 4000 / 6000
NTE4/18-33/DD/M3L/830-40-60	1174	18 / 23 / 28 / 33	2887 / 3625 / 4288 / 4991	160 / 161 / 160 / 158	Digital Dimming	M3L	>80	3000 / 4000 / 6000
NTE5/18-32/DD/830-40-60	1464	18 / 23 / 27 / 32	2924 / 3747 / 4439 / 5187	161 / 167 / 166 / 165	Digital Dimming		>80	3000 / 4000 / 6000
NTE5/18-32/DD/M3L/830-40-60	1464	18 / 23 / 27 / 32	2924 / 3747 / 4439 / 5187	161 / 167 / 166 / 165	Digital Dimming	M3L	>80	3000 / 4000 / 6000
NTE5/29-52/DD/830-40-60	1464	29 / 37 / 45 / 52	4794 / 5923 / 7058 / 8132	168 / 167 / 164 / 162	Digital Dimming		>80	3000 / 4000 / 6000
NTE5/29-52/DD/M3L/830-40-60	1464	29 / 37 / 45 / 52	4794 / 5923 / 7058 / 8132	168 / 167 / 164 / 162	Digital Dimming	M3L	>80	3000 / 4000 / 6000
NTE6/21-38/DD/830-40-60	1734	21 / 27 / 32 / 38	3377 / 4270 / 5067 / 5925	164 / 165 / 164 / 162	Digital Dimming		>80	3000 / 4000 / 6000
NTE6/21-38/DD/M3L/830-40-60	1734	21 / 27 / 32 / 38	3377 / 4270 / 5067 / 5925	164 / 165 / 164 / 162	Digital Dimming	M3L	>80	3000 / 4000 / 6000
NTE6/32-58/DD/830-40-60	1734	32 / 40 / 50 / 58	5165 / 6388 / 7705 / 8827	164 / 163 / 160 / 157	Digital Dimming		>80	3000 / 4000 / 6000
NTE6/32-58/DD/M3L/830-40-60	1734	32 / 40 / 50 / 58	5165 / 6388 / 7705 / 8827	164 / 163 / 160 / 157	Digital Dimming	M3L	>80	3000 / 4000 / 6000

* RESULTS @ 4000K

NOTE: DD includes DALI and Switch Dim

Emergency Conversion Packs

ORDER CODE	MOUNTING	POWER (W)	EMERGENCY
N/LINEAR/M3L/CONV-PACK	INTERNAL	2	Manual-test
N/LINEAR/STM3L/CONV-PACK	INTERNAL	2	Self-test

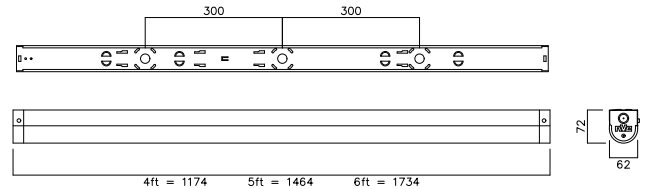

MW Sensor

ORDER CODE	DESCRIPTION
NTE/NRG/MW-SENSOR/PACK	Plug & Play MW Sensor Pack for Texas Pro & Ranger



A micro-wave sensor is available to be supplied ready fitted (MW) or purchased as a separate item and installed on-site, as listed overleaf.



SCAN QR CODE TO DOWNLOAD CATALOGUE PAGE



NVC LIGHTING LTD
 NVC Park 201, Hollymoor Way, Rubery, Birmingham, B31 5HE UK
 +44 (0)121 457 6340 | sales@nvcuk.com | www.nvcuk.com

